



VIDEOS &
FURTHER
INFORMATION



goto.vdocyclecomputer.com/r2wl/service

CONTENTS

R2 wired
1 + 2 + 3

R2 WR

1 Cable mount
Art.-Nr. 64930

2 Magnet
Art.-Nr. 64934

3 Cable ties

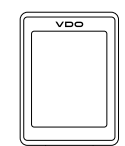

R2 wireless
3 + 4 + 5 + 6

R2 WL

4 Speed transmitter
Art.-Nr. 64937

5 Mount
Art.-Nr. 64931

6 Power Magnet
Art.-Nr. 64935

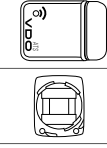
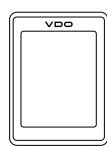

First Start

Press 5 sec.

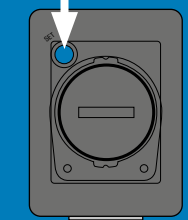

Battery already installed / Pili zaten takılı /
Bateria deja instalată / Батерията вече е поставена /
Batéria je nainštalovaná / Baterija je že nameščena /
Baterija je već instalirana / Акумулятор установлено /
Baterie je již nainstalována

INSTALLATION MOUNT

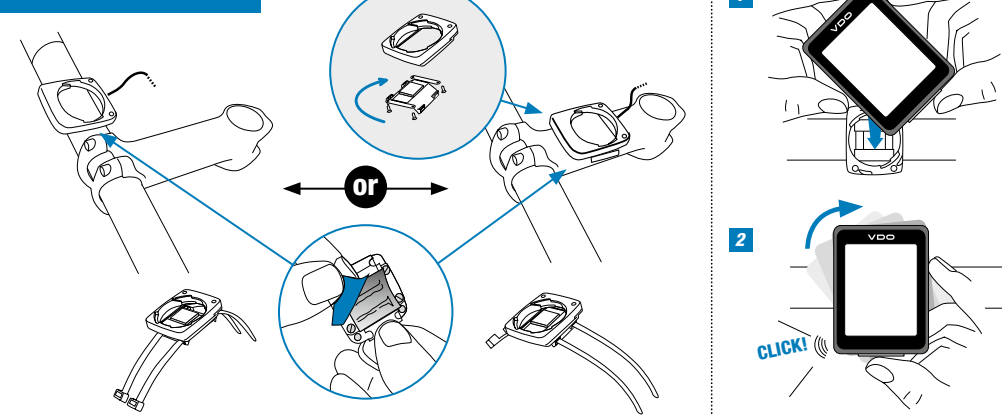

INSTALLATION WIRED SPEED SENSOR

WIRED

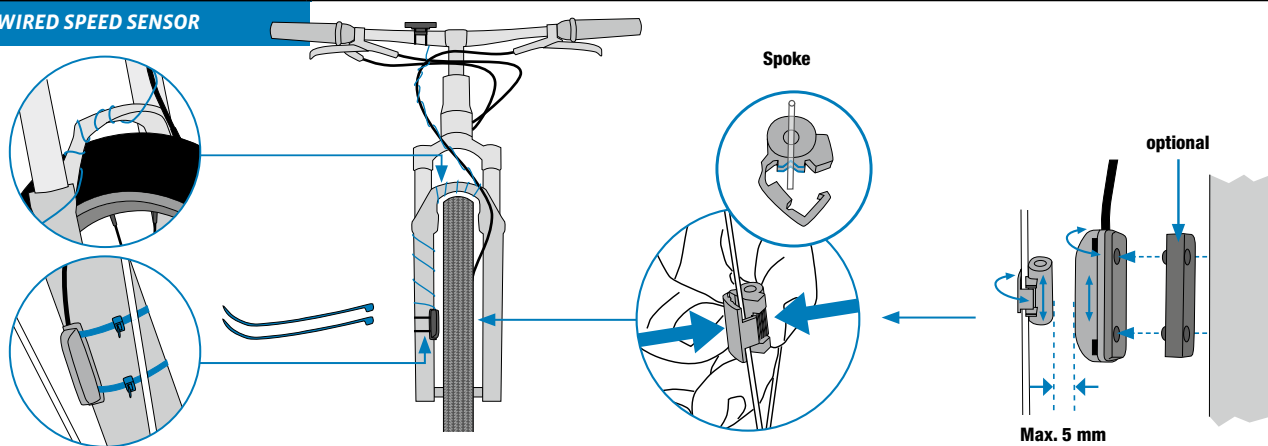

INSTALLATION WIRELESS SPEED TRANSMITTER

Emission frequency: 112 kHz, Max power < 11.37 dBm
Operation temperature: -10°C to 60°C



WIRELESS

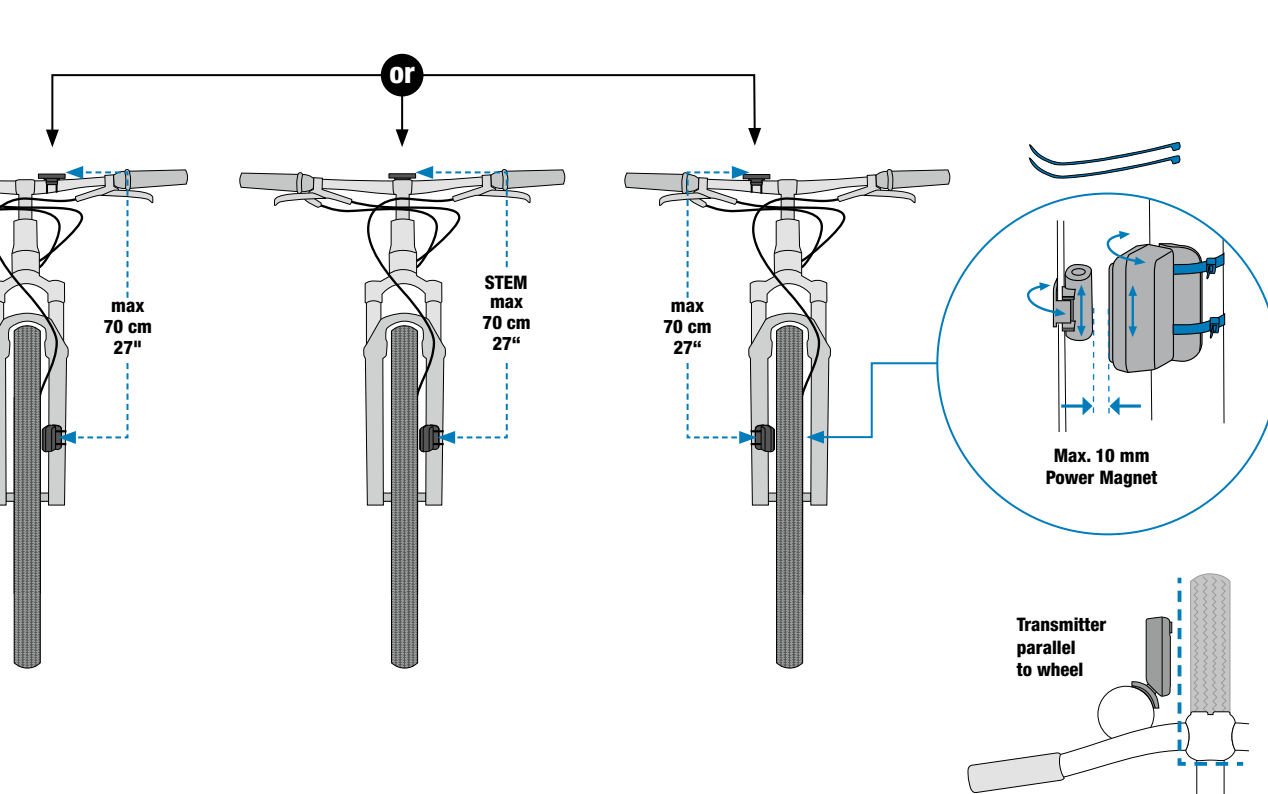

EV Computer WIRED:
- Battery type: CR 2032, 3V
- Battery life: 3 years
(When used for 1 hour per day)

Computer WIRELESS:
- Battery type: CR 2032, 3V
- Battery life: 2 years
(When used for 1 hour per day)

Transmitter:
- Battery type: CR 2032, 3V
- Battery life: 1.5 years
(When used for 1 hour per day)

TR Kilometre Saati KABLULU:
- Pili türü: CR 2032, 3V
- Pili ömrü: 3 yıl
(Günde 1 saat kullanıldığında)

Kilometre Saati KABLOSUZ:
- Pili türü: CR 2032, 3V
- Pili ömrü: 2 yıl (Günde 1 saat kullanıldığında)

Verici:
- Pili türü: CR 2032, 3V
- Pili ömrü: 1,5 yıl
(Günde 1 saat kullanıldığında)

RO Calculator CABLAT:
- Tipul de baterie: CR 2032, 3V
- Durata de viață a bateriei: 3 ani
(în cazul utilizării timp de 1 oră pe zi)

Calculator WIRELESS:
- Tipul de baterie: CR 2032, 3V
- Durata de viață a bateriei: 2 ani
(în cazul utilizării timp de 1 oră pe zi)

Transmițător:
- Tipul de baterie: CR 2032, 3V
- Durata de viață a bateriei: 1,5 ani
(în cazul utilizării timp de 1 oră pe zi)

BG Компютър с КАБЕЛНА връзка:
- Тип батерия: CR 2032, 3 V
- Живот на батерията: 3 години
(Ако се използва по един час на ден)

Компютър с БЕЗЖИЧНА връзка:
- Тип батерия: CR 2032, 3 V
- Живот на батерията: 2 години
(Ако се използва по един час на ден)

Предавател:
- Тип батерия: CR 2032, 3 V
- Живот на батерията: 1,5 години
(Ако се използва по един час на ден)

SK Počítač je KÁBLOVÝ:
- Typ batérie: CR 2032, 3 V
- Životnosť batérie: 3 roky
(ak sa používa 1 hodinu denne)

Počítač NIE JE KÁBLOVÝ:
- Typ batérie: CR 2032, 3 V
- Životnosť batérie: 2 roky
(ak sa používa 1 hodinu denne)

Vysielač:
- Typ batérie: CR 2032, 3 V
- Životnosť batérie: 1,5 roka
(ak sa používa 1 hodinu denne)

SL Računalnik je POVEZAN:
- tip baterije: CR 2032, 3 V
- življenjska doba baterije: 3 leta
(če jo uporabljate eno uro na dan)

Računalnik ni POVEZAN:
- tip baterije: CR 2032, 3 V
- življenjska doba baterije: 2 leti
(če jo uporabljate eno uro na dan)

Oddajnik:
- tip baterije: CR 2032, 3 V
- življenjska doba baterije: 1,5 leta
(če jo uporabljate eno uro na dan)

HR Računalo ŽIČANO:
- Vrsta baterije: CR 2032, 3 V
- Vijek trajanja baterije: 3 godine
(kada se upotrebljava 1 sat dnevno)

Računalo BEŽIČNO:
- Vrsta baterije: CR 2032, 3 V
- Vijek trajanja baterije: 2 godine
(kada se upotrebljava 1 sat dnevno)

Odašiljač:
- Vrsta baterije: CR 2032, 3 V
- Vijek trajanja baterije: 1,5 godinu
(kada se upotrebljava 1 sat dnevno)

UA Комп'ютер ІЗ ПРОВОДОВИМ ПІД'ЄДНАННЯМ:
- тип акумулятора: CR 2032, 3 В;
- термін служби акумулятора: 3 роки
(за умови використання протягом 1 години на день).

Комп'ютер ІЗ БЕЗПРОВОДОВИМ ПІД'ЄДНАННЯМ:
- тип акумулятора: CR 2032, 3 В;
- термін служби акумулятора: 2 роки (за умови використання протягом 1 години на день).

Передавач:
- тип акумулятора: CR 2032, 3 В;
- термін служби акумулятора: 1,5 роки (за умови використання протягом 1 години на день).

CZ Computer S KABELOVÝM PŘIJOJENÍM:
- Typ baterie: CR 2032, 3V
- Životnost baterie: 3 roky
(při používání 1 hodinu denně)

BEZDRÁTOVÝ computer:
- Typ baterie: CR 2032, 3V
- Životnost baterie: 2 roky
(při používání 1 hodinu denně)

Vysílač:
- Typ baterie: CR 2032, 3V
- Životnost baterie: 1,5 roku
(při používání 1 hodinu denně)

EU-DECLARATION OF CONFORMITY

We, SIGMA-ELEKTRO GmbH, Dr.-Julius-Leber-Str. 15, D-67433 Neustadt/Weinstraße declare under our responsibility that the product R2 WR are compliant with the essential requirements of the EMC Directive 2014/30/EU and the RoHS Directive 2011/65/EU. The declaration of conformity can be found at: ce.vdocyclecomputer.com/r2wl

We, SIGMA-ELEKTRO GmbH, Dr.-Julius-Leber-Str. 15, D-67433 Neustadt/Weinstraße declare under our responsibility that the product R2 WL and the transmitter ATS2021 are compliant with the essential requirements and other relevant requirements of the RED Directive 2014/53/EU and the RoHS Directive 2011/65/EU. The declaration of conformity can be found at: ce.vdocyclecomputer.com/r2wl

EU-KONFORMITÄTSEKTLÄRUNG

Wir, SIGMA-ELEKTRO GmbH, Dr.-Julius-Leber-Str. 15, D-67433 Neustadt/Weinstraße, erklären, dass der Fahrradcomputer R2 WR bei bestimmungsgemäßer Verwendung den grundlegenden Anforderungen gemäß der EMC Directive 2014/30/EU und der RoHS Directive 2011/65/EU entspricht. Sie finden die Konformitäts-Erklärung unter folgendem Link: ce.vdocyclecomputer.com/r2wl

Wir, SIGMA-ELEKTRO GmbH, Dr. Julius Leber Str. 15, D-67433 Neustadt/Weinstraße erklären, dass der Fahrradcomputer mit Funkübertragung R2 WL und der Sender ATS2021 bei bestimmungsgemäßer Verwendung den grundlegenden Anforderungen gemäß RED Directive 2014/53/EU und der RoHS Directive 2011/65/EU entsprechen. Sie finden die Konformitäts-Erklärung unter folgendem Link: ce.vdocyclecomputer.com/r2wl

FEDERAL COMMUNICATION COMMISSION INTERFERENCE STATEMENT

Caution: If any changes or modifications not expressly approved by the party responsible for compliance could void the user's authority to operate the equipment.

This device complies with Part 15 of the FCC Rules. Operation is subject to the following two conditions:
(1) This device may not cause harmful interference, and
(2) This device must accept any interference received, including interference that may cause undesired operation.

The grantee is not responsible for any changes or modifications not expressly approved by the party responsible for compliance. Such modifications could void the user's authority to operate the equipment.

The RF Exposure Compliance distance is 5 millimeters.

NOTE: This equipment has been tested and found to comply with the limits for a Class B digital device, pursuant to part 15 of the FCC Rules. These limits are designed to provide reasonable protection against harmful interference in a residential installation. This equipment generates, uses and can radiate radio frequency energy and, if not installed and used in accordance with the instructions, may cause harmful interference to radio communications. However, there is no guarantee that interference will not occur in a particular installation. If this equipment does cause harmful interference to radio or television reception, which can be determined by turning the equipment off and on, the user is encouraged to try to correct the interference by one or more of the following measures:

- Reorient or relocate the receiving antenna.
- Increase the separation between the equipment and receiver.
- Connect the equipment into an outlet on a circuit different from that to which the receiver is connected.
- Consult the dealer or an experienced radio/TV technician for help.

ATS2021 FCC ID: M5LATS2021

INDUSTRY CANADA STATEMENT

This device complies with Innovation, Science and Economic Development Canada licence-exempt RSS standard(s).

Operation is subject to the following two conditions:
(1) this device may not cause interference, and
(2) this device must accept any interference, including interference that may cause undesired operation of the device.

CAN ICES-3(B)/NMB-3(B)

Le présent appareil est conforme aux CNR Innovation, Sciences et Développement économique Canada applicables aux appareils radio exempts de licence.

L'exploitation est autorisée aux deux conditions suivantes:

- (1) il ne doit pas produire de brouillage et
- (2) l'utilisateur du dispositif doit être prêt à accepter tout brouillage radioélectrique reçu, même si ce brouillage est susceptible de compromettre le fonctionnement du dispositif.

CAN ICES-3(B)/NMB-3(B)

The device meets the exemption from the routine evaluation limits in section 2.5 of RSS 102 and compliance with RSS-102 RF exposure, users can obtain Canadian information on RF exposure and compliance.

Le dispositif rencontre l'exemption des limites courantes d'évaluation dans la section 2.5 de RSS 102 et la conformité à l'exposition de RSS-102 rf, utilisateurs peut obtenir l'information canadienne sur l'exposition et la conformité de rf.

This transmitter must not be co-located or operating in conjunction with any other antenna or transmitter. This equipment should be installed and operated with a minimum distance of 5 millimeters between the radiator and your body.

Cet émetteur ne doit pas être Co-placé ou ne fonctionnant en même temps qu'aucune autre antenne ou émetteur. Cet équipement devrait être installé et actionné avec une distance minimum de 5 millimètres entre le radiateur et votre corps.

UKCA STATEMENT

Wireless Model

We, SIGMA-ELEKTRO GmbH, declare that the equipment above has been tested in our facility and found compliance with the requirement limits of applicable standards, in accordance with the Radio Equipment

Regulations 2017 and the Restriction of the Use of Certain Hazardous Substances in Electrical and Electronic Equipment Regulations 2012. The test record, data evaluation and Equipment Under Test (EUT) configurations represented herein are true and accurate under the standards herein specified.

Wired Model

We, SIGMA-ELEKTRO GmbH, declare that the equipment above has been tested in our facility and found compliance with the requirement limits of applicable standards, in accordance with the Electromagnetic Compatibility

Regulations 2016 and the Restriction of the Use of Certain Hazardous Substances in Electrical and Electronic Equipment Regulations 2012. The test record, data evaluation and Equipment Under Test (EUT) configurations represented herein are true and accurate under the standards herein specified.

CE INFORMATION

EV You can find the CE declaration at: ce.vdocyclecomputer.com/r2wl

TR CE beyanını şurada bulabilirsiniz: ce.vdocyclecomputer.com/r2wl

RO Declarația CE o găsiți la: ce.vdocyclecomputer.com/r2wl

BG Можете да откриете Декларацията за съответствие на: ce.vdocyclecomputer.com/r2wl

SK Vyhľadanie CE nájdete na: ce.vdocyclecomputer.com/r2wl

SL Izjava CE najdete na: ce.vdocyclecomputer.com/r2wl

HR Oznaku CE možete pronaći na: ce.vdocyclecomputer.com/r2wl

UA Oznaku CE možete pronaći na: ce.vdocyclecomputer.com/r2wl

CZ ES prohlášení najdete na adrese: ce.vdocyclecomputer.com/r2wl

Functions / Settings

BUTTON OVERVIEW

EN

- SET Button: S**
- Short press = SET/OK
 - Long press >3 sec. = Open/Close Settings

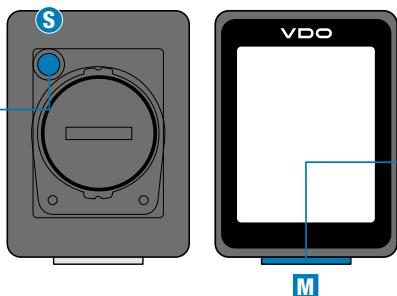

MENU Button: M

- Short press = Toggle/Increase value
- Long press >3 sec. = Reset tour data

MENU BASIC BIKE FUNCTIONS

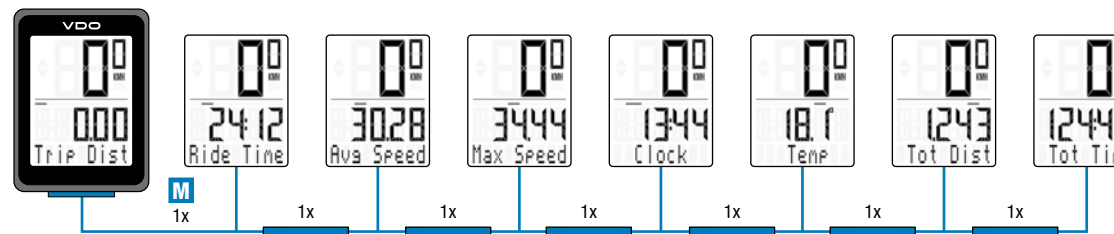

DISPLAY OVERVIEW

EN

- Higher/lower average speed
- 1
- KMH or MPH selected
- 2

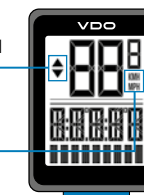

- TR** 1: Daha yüksek/daha düşük ortalama hız
2: KM/H veya MPH seçili
- RO** 1: Viteză medie mai mare/mai mică
2: Selectare KM/H sau MPH
- BG** 1: По-висока/по-ниска средна скорост
2: Избрано километри в час или мили в час
- SK** 1: Vyššia/nížšia priemerná rýchlosť
2: Zvolili ste KM/H alebo MPH
- SL** 1: Zvečaj/zmanjšaj povprečno hitrost
2: Izbrani so KM/H ali MPH
- HR** 1: veća/manja prosječna brzina
2: odabrano km/h ili mph
- UA** 1: вища/нижча середня швидкість
2: обрано км/год або миль/год
- CZ** 1: Vyšší/nížší průměrná rychlost;
2: Vyběr KM/H nebo MILE/H

TR

- S: SET (Ayar) Düğmesi:**
- Kısa basım = SET (Ayar)/OK (Tamam)
 - Uzun basım = Ayarları Açar/Kapatır
- M: MENU (Menü) Düğmesi:**
- Kısa basım = Değeri değiştirir/Değeri artırır
 - Uzun basım = Tur verilerini sıfırlar

RO

- S: Butonul SETARE:**
- Apăsare scurtă = SETARE/OK
 - Apăsare lungă = deschidere/închidere setări
- M: Butonul MENU:**
- Apăsare scurtă = comutare/creșterea valorii
 - Apăsare lungă = resetarea datelor turului

BG

- S: БУТОН SET (НАСТРОЙКА):**
- Кратко натискане = Настройване/OK
 - Дълго натискане = Отваряне/затваряне на настройките
- M: БУТОН MENU (МЕНЮ):**
- Кратко натискане = Превключване/увеличаване на стойността
 - Дълго натискане = Нулиране на данните за обиколката

SK

- S: Tlačidlo NASTAVIŤ:**
- Krátke stlačenie = NASTAVIŤ/OK
 - Dlhé stlačenie = otvorit/zatvorit nastavenia
- M: Tlačidlo MENU:**
- Krátke stlačenie = Prepnúť/zvýšiť hodnotu
 - Dlhé stlačenie = Obnoviť údaje o dráhe

SL

- S: Gumb SET (nastavi):**
- kratek pritisk na gumb = SET/OK
 - dolg pritisk na gumb = odpri/zapri nastavitve
- M: Gumb MENU (meni):**
- kratek pritisk na gumb = preklopi/poveča vrednost
 - dolg pritisk na gumb = ponastavitev podatkov o turi

HR

- S: Gumb POSTAVI:**
- Kratak pritisk = POSTAVI / U REDU
 - Dug pritisk = otvaranje/zatvaranje postavki
- M: Gumb IZBORNIK:**
- Kratak pritisk = prebacivanje / povećavanje vrijednosti
 - Dug pritisk = ponovno postavljanje podataka o turi

UA

- S: Кнопка «НАЛАШТУВАННЯ»:**
- коротке натискання = «НАЛАШТУВАННЯ»/OK.
 - довге натискання = відкрити/закрити налаштування;
- M: Кнопка «МЕНЮ»:**
- коротке натискання = перемикання/збільшення значення;
 - довге натискання = скидання даних про подорож.

CZ

- S: Tlačítko SET:**
- Krátké stisknutí = NASTAVIT/OK
 - Dlouhé stisknutí = Otevření/zavření nastavení
- M: Tlačítko MENU:**
- Krátké stisknutí = Přepnutí / Zvýšení hodnoty
 - Dlouhé stisknutí = Reset dat jízdy

SETTINGS MENU

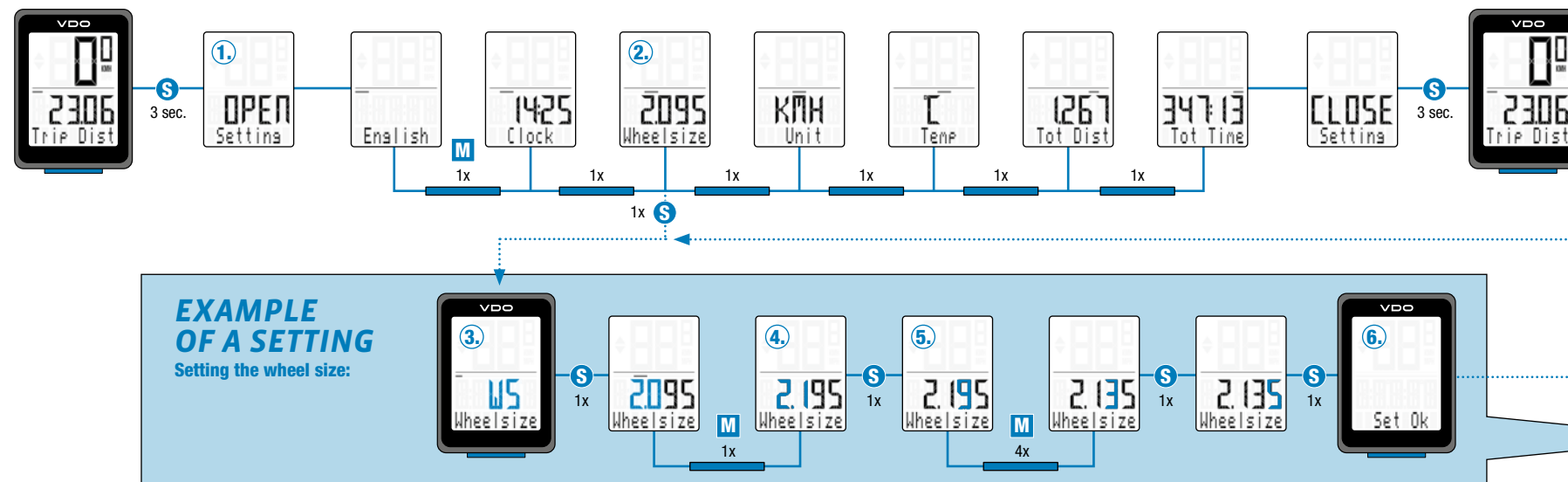

CHOOSE YOUR SPECIFIC WHEEL SIZE

mm	inch
16"	1253 49,3
18"	1411 55,6
20"	1590 62,6
22"	1770 69,7
24"	1907 75,1
26"	2085 82,1
27"	2195 86,4
27.5"	2180 85,8
28"	2200 86,6
29"	2300 90,5
700C	2095 82,5

km/h:
WS = mm
mph:
WS = mm
Note: 1 inch = 25.4 mm

EXAMPLE VALUE: 2135 mm

EN EXAMPLE OF SETTING PROCEDURE:

1. **Open settings:** Press and hold **S** button > 3 sec. until settings open.
2. **Choose the relevant page:** Press **M** button until desired value is displayed.
3. **Open submenu:** Press 1x **S** button.
4. **Change value:** Press **M** button until desired value is displayed.
5. **Confirm chosen value:** Press 1x **S** button.
Note: Do steps No. 4 and No. 5 until the submenu is closed „Set Ok“. You are now back in the Settings Menu.
6. **Close settings:** Press and hold **S** button > 3 sec.

TR AYAR İŞLEMİ ÖRNEĞİ:

1. **Ayarları açın:** Ayarlar açılana kadar **S** (Ayar) düğmesine en az 3 sn. basılı tutun.
2. **İlgili sayfayı seçin:** İstenen değer görüntülenene kadar **M** (Menü) düğmesine basın.
3. **Alt menüyü açın:** **S** (Ayar) düğmesine 1 kez basın.
4. **Değeri değiştirin:** İstenen değer görüntülenene kadar **M** (Menü) düğmesine basın.
5. **Seçilen değeri onaylayın:** **S** (Ayar) düğmesine 1 kez basın.
Not: Alt menü kapanana kadar 4 ve 5 numaralı adımları gerçekleştirin „Set Ok“ (Ayar/Tamam). Şimdi yeniden Ayarlar Menüsündesiniz.
6. **Ayarları kapatın:** Ayarlar açılana kadar **S** (Ayar) düğmesine en az 3 sn. basılı tutun.

RO EXEMPLU DE PROCEDURĂ DE SETARE:

1. **Deschideți setările:** apăsați și țineți apăsat butonul **S** >3 sec. până când se deschid setările.
2. **Alegeți pagina relevantă:** apăsați butonul **M** până când este afișată valoarea dorită.
3. **Deschideți submenuul:** apăsați 1 dată butonul **S**.
4. **Modificați valoarea:** apăsați butonul **M** până când este afișată valoarea dorită.
5. **Confirmați valoarea aleasă:** apăsați 1 dată butonul **S**.
Notă: urmați pașii nr. 4 și nr. 5 până când submenuul este închis „Setare Ok“. Acum sunteți din nou în meniul Setări.
6. **Închideți setările:** apăsați și țineți apăsat butonul **S** >3 sec.

BG ПРИМЕР ЗА ПРОЦЕДУРАТА ПО НАСТРОЙВАНЕ:

1. **Отваряне на настройките:** Натиснете и задръжте бутона **S** за повече от 3 секунди, докато се отворят настройките.
2. **Избиране на съответната страница:** Натиснете бутона **M**, докато се появи желаната стойност.
3. **Отваряне на подменю:** Натиснете веднъж бутона **S**.
4. **Промяна на стойност:** Натиснете бутона **M**, докато се появи желаната стойност.
5. **Потвърждаване на избраната стойност:** Натиснете веднъж бутона **S**.
Бележка: Извършвайте стъпки 4 и 5, докато подменюто се затвори – „Настройка ОК“ (Set Ok). Сега отново сте в Менюто с настройките.
6. **Затваряне на настройките:** Натиснете и задръжте бутона **S** за повече от 3 секунди.

SK PŘÍKLAD POSTUPU NASTAVENIA:

1. **Otvoríť nastavenia:** stlačte a podržte tlačidlo **S** > 3 sekundy, kým sa neotvorí nastavenia.
2. **Zvolíť príslušnú stránku:** stlačte tlačidlo **M**, kým sa nezobrazí požadovaná hodnota.
3. **Otvoríť podmenu:** stlačte tlačidlo **S** 1-krát.
4. **Zmeníť hodnotu:** stlačte tlačidlo **M**, kým sa nezobrazí požadovaná hodnota.
5. **Potvrdíť zvolenú hodnotu:** stlačte tlačidlo **S** 1-krát.
Upozornenie: opakujte kroky č. 4 a č. 5, kým sa podmenu nezatvorí. Vrátili ste sa späť do menu Nastavenia.
6. **Zatvoríť nastavenia:** stlačte a podržte tlačidlo **S** > 3 sekundy.

SL PRIMER POSTOPKA NASTAVITVE:

1. **Odprí nastavitve:** pritisnite in pridržite gumb **S** >3 sekunde oz. dokler se ne odprejo nastavitve.
2. **Izberite ustrezno stran:** pritisnite gumb **M** dokler se ne prikaže zelena vrednost.
3. **Odprite podmeni:** 1 x pritisnite gumb **S**.
4. **Spremeni vrednost:** pritisnite gumb **M** dokler se ne prikaže zelena vrednost.
5. **Potrdite izbrano vrednost:** 1 x pritisnite gumb **S**.
Opomba: 4. in 5. korak izvajajte dokler se ne zapre podmeni „Set ok“. Po tem boste vrnjeni v meni Nastavitve.
6. **Zapri nastavitve:** pritisnite in pridržite gumb **S** >3 sekunde.

HR PRIMJER POSTUPKA POSTAVLJANJA:

1. **Otvoranje postavki:** pritisnite i držite gumb **S** duže od 3 sekunde, dok se ne prikaže željena vrijednost.
2. **Odabir važne stranice:** pritisnite gumb **M** dok se ne prikaže željena vrijednost.
3. **Otvoranje podizbornika:** jednom pritisnite gumb **S**.
4. **Promjena vrijednosti:** pritisnite gumb **M** dok se ne prikaže željena vrijednost.
5. **Potvrda odabrane vrijednosti:** jednom pritisnite gumb **S**.
Napomena: ponavljajte 4. i 5. korak dok se podizbornik ne zatvori „Postavke su u redu“. Vratili ste se u Izbornik postavki.
6. **Zatvaranje postavki:** pritisnite i držite gumb **S** duže od 3 sekunde.

UA ПРИКЛАД ПРОЦЕСУ НАЛАШТУВАННЯ:

1. **Відкрийте налаштування:** натисніть і утримуйте кнопку **S** понад 3 с, доки не відкриється вкладка налаштувань.
2. **Оберіть відповідну сторінку:** натискайте кнопку **M**, доки не з'явиться необхідне значення.
3. **Відкрийте підменю:** 1 раз натисніть кнопку **S**.
4. **Змініть значення:** натискайте кнопку **M**, доки не з'явиться необхідне значення.
5. **Підтвердіть обране значення:** 1 раз натисніть кнопку **S**.
Примітка: виконуйте кроки № 4 та № 5, доки підменю не закриється з повідомленням «Налаштування ОК». Ви повернулись у меню налаштувань.
6. **Закрийте налаштування:** натисніть та утримайте кнопку **S** понад 3 с.

CZ PŘÍKLAD POSTUPU NASTAVENÍ:

1. **Otevření nastavení:** Stiskněte a podržte tlačítko **S** po dobu > 3 s, dokud se nastavení neotevře.
2. **Volba příslušné stránky:** Mačkejte tlačítko **M**, dokud se neobjeví požadovaná hodnota.
3. **Otevření podmenu:** Stiskněte 1x tlačítko **S**.
4. **Změna hodnoty:** Mačkejte tlačítko **M**, dokud se neobjeví požadovaná hodnota.
5. **Potvrzení zvolené hodnoty:** Stiskněte 1x tlačítko **S**.
Poznámka: Opakujte kroky 4 a 5, dokud se podmenu nezavře „Nastavení OK“. Nyní jste zpět v menu Nastavení.
6. **Zavření nastavení:** Stiskněte a podržte tlačítko **S** po dobu > 3 s.

BATTERY CHANGE

R2 WR / WL

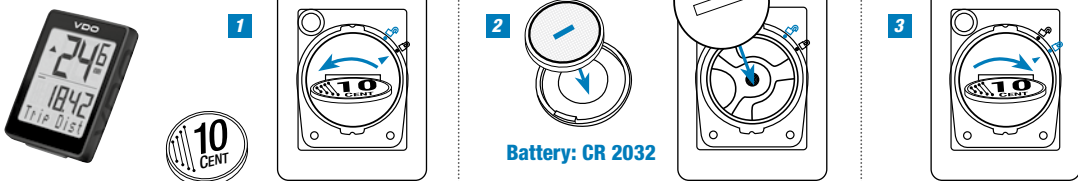

Battery: CR 2032

SPEED TRANSMITTER (R2 WL)

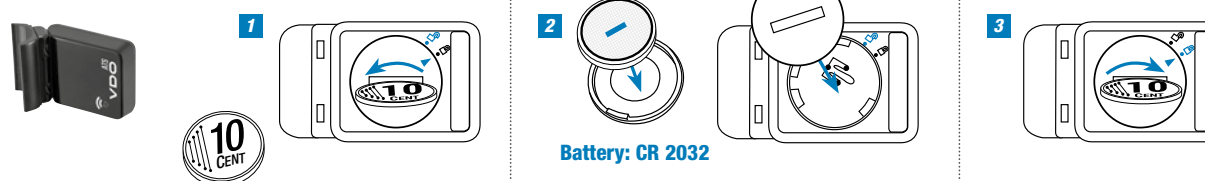

Battery: CR 2032

SIGMA-ELEKTRO GmbH
Dr.-Julius-Leber-Straße 15
67433 Neustadt/Weinstraße, Germany
kundenservice@sigmasport.com

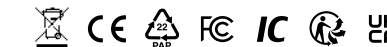

684120/1